

SAFARI 1D1W

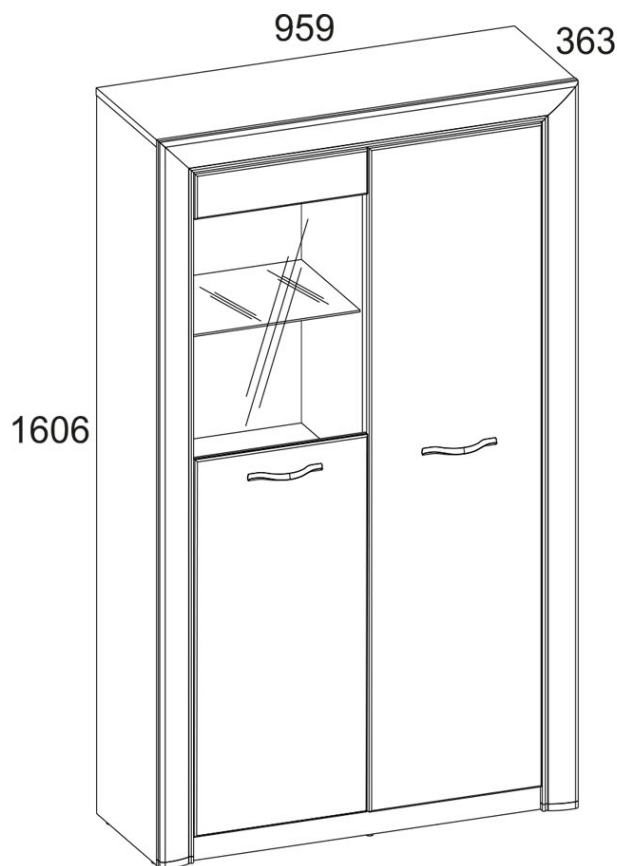

Koda	L, mm	B, mm	H, mm		paket
1	958	335	16	1	1/2
2	924	335	16	1	1/2
3	454	335	16	1	1/2
4	454	335	16	1	1/2
5	452	325	6	1	1/2
6	452	335	16	3	1/2
7	1585	335	16	1	2/2
8	1585	335	16	1	2/2
9	1514	335	16	1	2/2
10	924	55	16	2	1/2
11	1464	396	16	1	2/2
13	1464	396	16	1	2/2
15	1587	80	25	1	2/2
16	1587	80	25	1	2/2
17	959	80	25	1	2/2
18	1540	475	2,5	1	2/2
19	1540	475	2,5	1	2/2

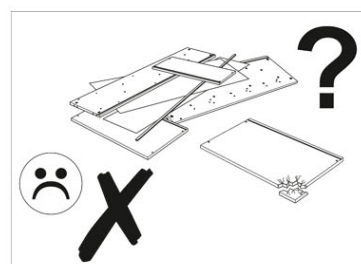

Pri uporabi pohištva je prepovedano:

- postavljati pohištva v bližino grelnih naprav in ob vlažne stene ter v prostore z relativno vlažnostjo nad 70 %;
- temperatura ogrevanja pohištvenih elementov ne sme presegati + 40 °C;
- med sestavljanjem in uporabo pohištva ne stojte z nogami na vodoravnih ploščah in oknih;
- za čiščenje pohištva ne uporabljajte kemičnih čistilnih sredstev;
- ne sme biti izpostavljeno vodi.

VONJ.

Novo pohištvo lahko oddaja vonj po materialih, iz katerih je izdelano. Vonj se lahko ohrani do tri tedne po namestitvi. Da bi zmanjšali intenzivnost vonja, je priporočljivo, da:

- pri oblaženem pohištvu - izdelek posesajte in prezračite prostor.

Ponovite 3-4-krat na dan.

-pri omarah - obrišite s krpo, navlaženo z blagim detergentom, obrišite s čisto, suho krpo in prezračite prostor ter najprej odprite vsa vrata in predale izdelka.

Ponovite 3-4-krat na dan. Pomembno! Navodila shranite za primer ponovnega sestavljanja pohištva ali reklamacij.

Pri vložitvi reklamacije uporabite oznake, ki so navedene v navodilih.





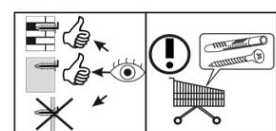
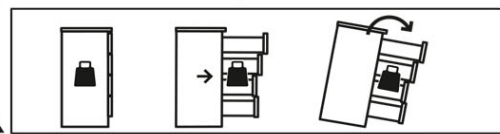

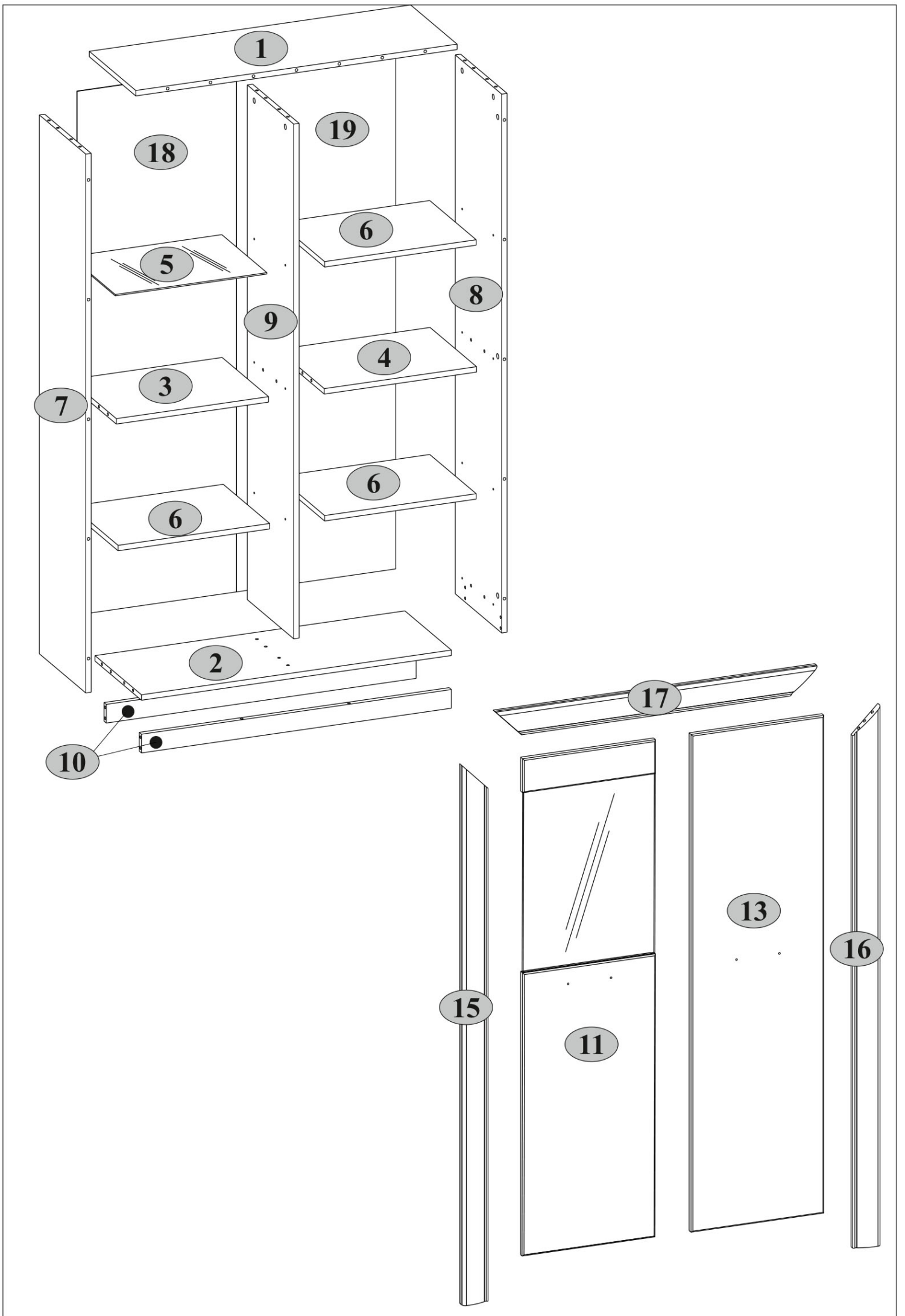

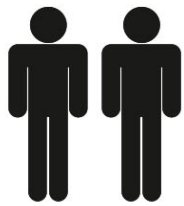





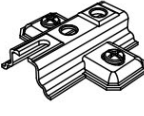
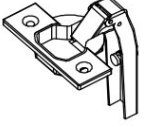





OPOZORILO! Padec kosa pohištva lahko zaradi zdrsa povzroči hude ali smrtne poškodbe. VEDNO pritrdite ta kos pohištva na steno z pritrilnimi elementi. Za opečne in betonske stene se uporablja vgrajeni zatič. Za pritrnitev na steno uporabite pritrilne elemente, primerne za material stene; če niste prepričani, katera vrsta pritrilnih elementov je primerna za material stene, se obrnite na strokovnjaka ali specializirano trgovino. Za pritrilne elemente je na koncu odgovoren izvajalec montaže. Za dodatno zmanjšanje tveganja hudih telesnih poškodb in smrti zaradi padca pohištva:

- Najtežje predmete položite v spodnji predal.
- Težkih predmetov ne postavljajte na zgornji del predala.
- Nikoli ne dovolite otrokom, da plezajo po predalih, vratih ali policah.
- Pohištvo uporabljajte v skladu s predvidenim namenom





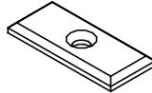

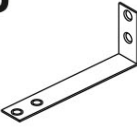
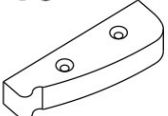

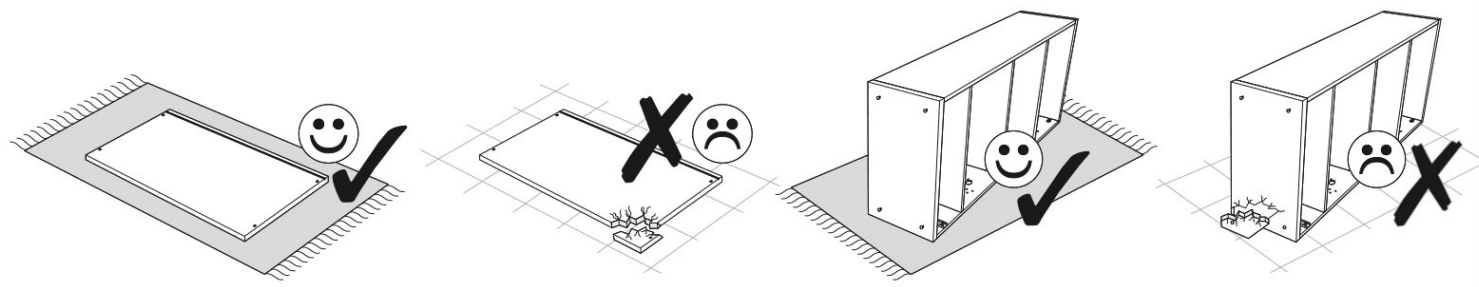
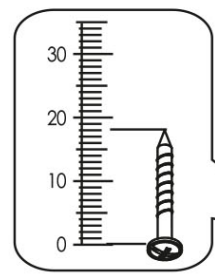
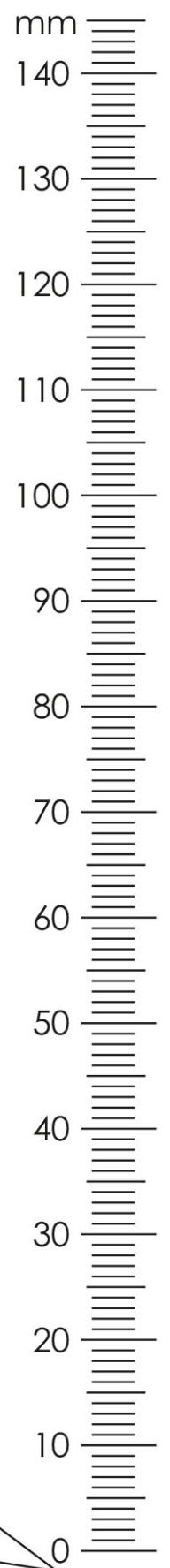
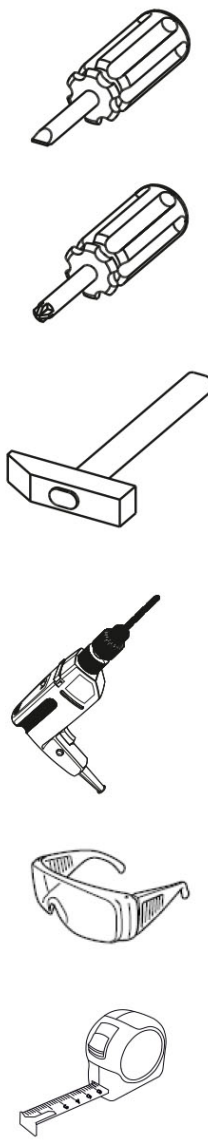



A1.0  5x28 28	A2  15x13 32	A9  L-47,4 2	B5  10x50 1
C1  8x35 43	D1  6	E2  6	G  1,5x26 40
H63  2	I  S4 1	M4  M4x22 4	N1  6
P1  Ø5 12	P4  4	Q  1,5x7 4	R3  3x20 5
R5  3x30 4	R23  6,3x13 12	R24  7x50 2	R102  3,5x16 14
S3  5	S5  Ø18 16	U  130x35x15 1	V16  80x25x15 2

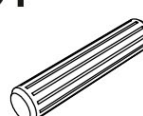



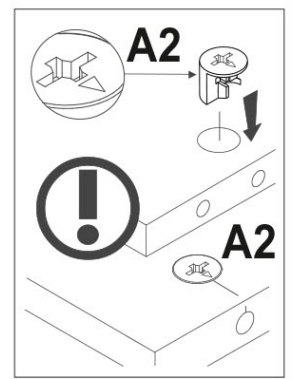
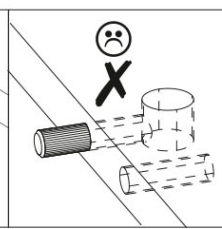
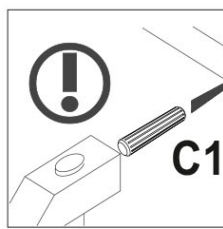
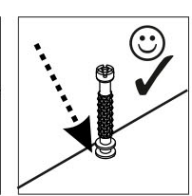
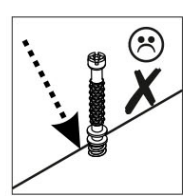
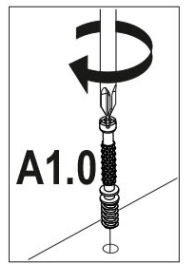
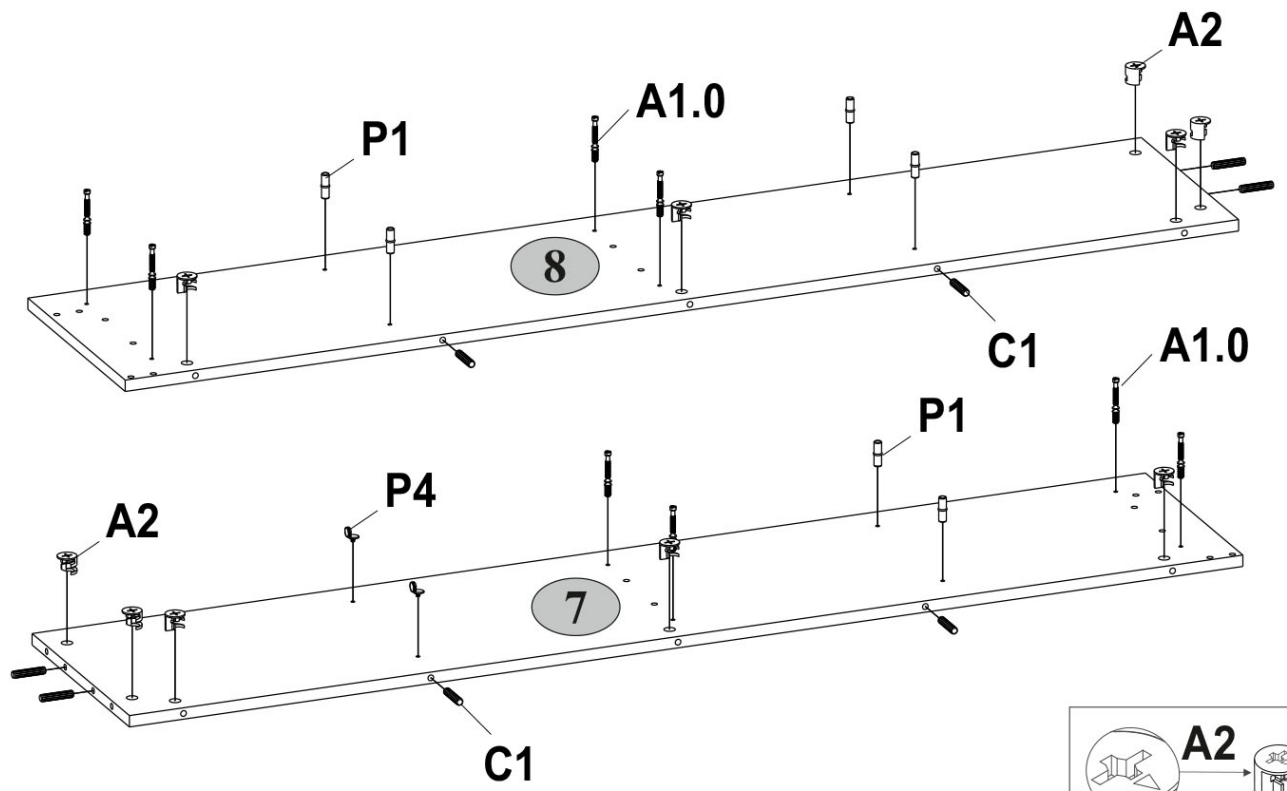

1

A1.0  5x28	A2  8 15x13	C1  10 8x35	P1  8 Ø5	P4  6	P4  2
--	---	---	---	---	---





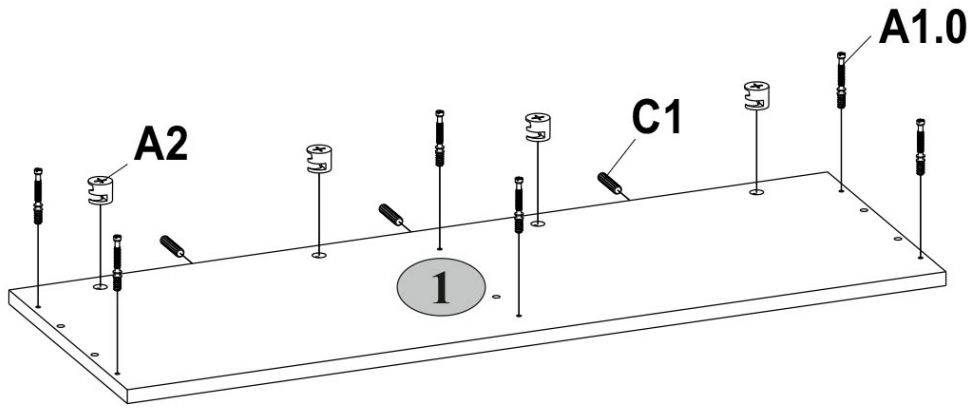

2

A1.0  5x28	A2  6 15x13	C1  4 8x35	C1  3
--	---	--	---



3

A1.0  5x28	A2  4 15x13	C1  2 8x35	P1  4 Ø5	P4  6 2
--	---	--	---	---

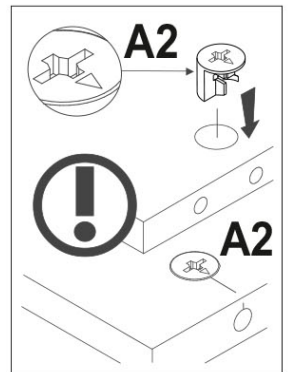
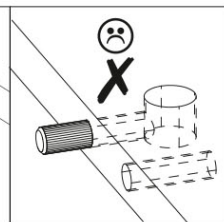
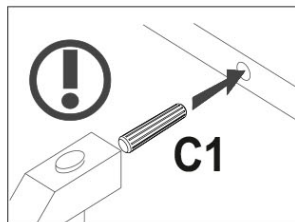
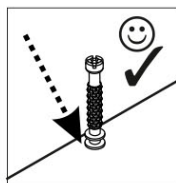
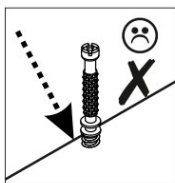
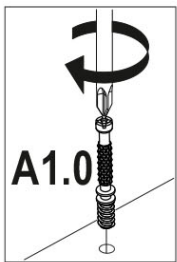
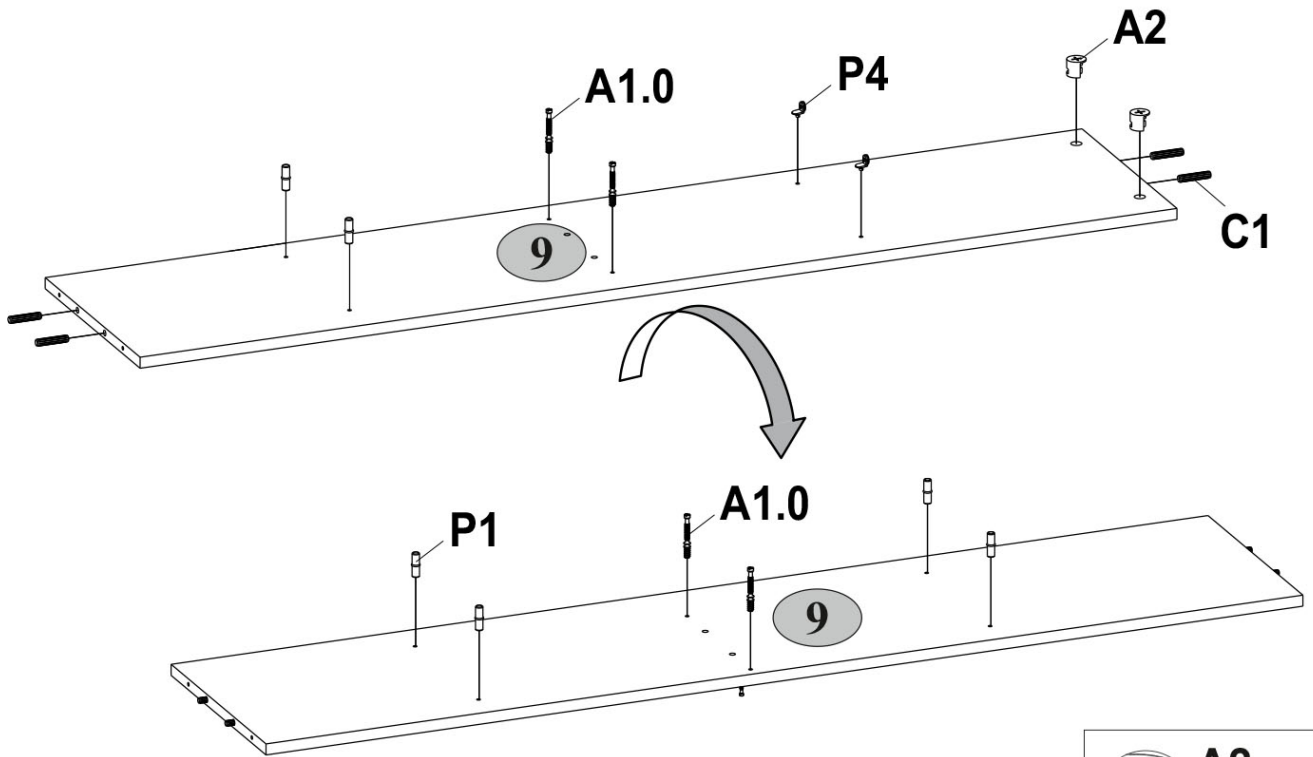

4

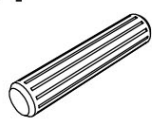
A2  15x13	C1  8 8x35
---	--

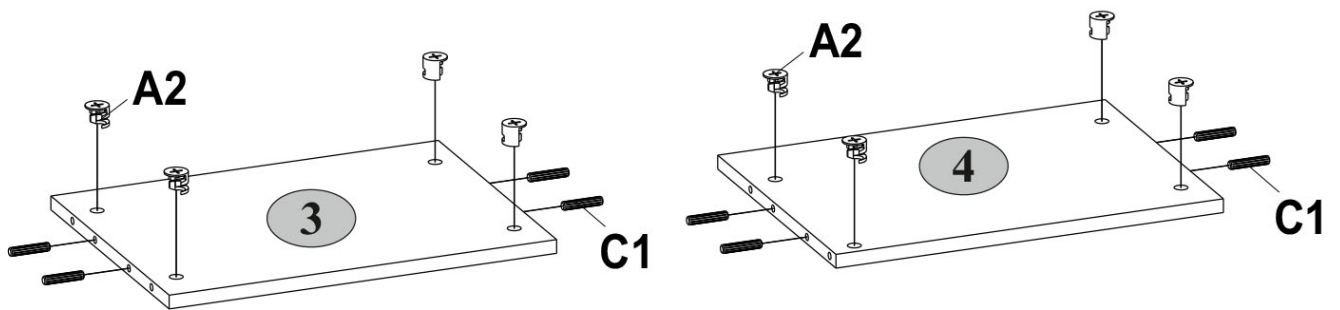

5

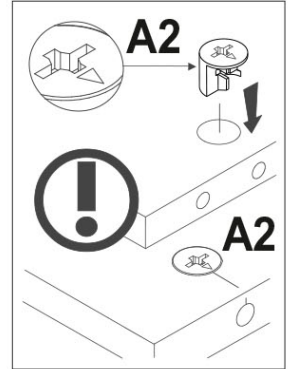
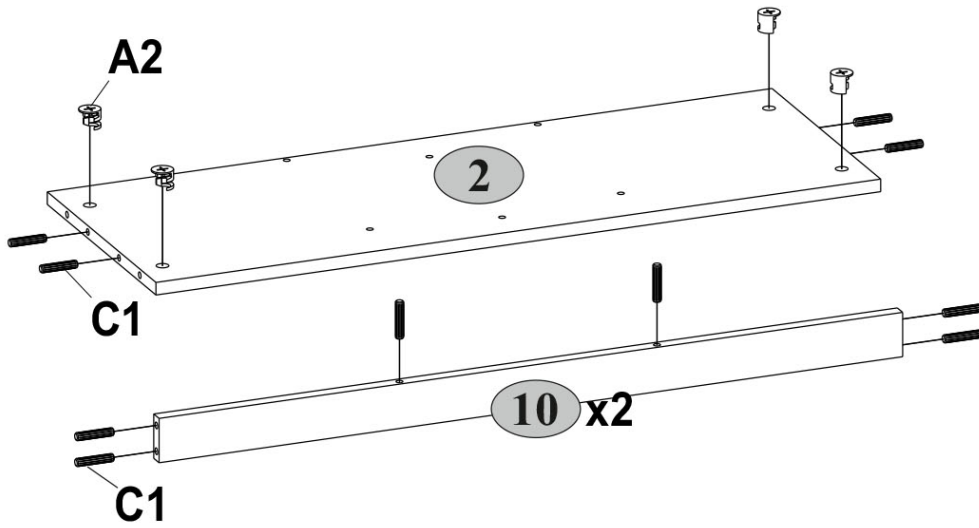
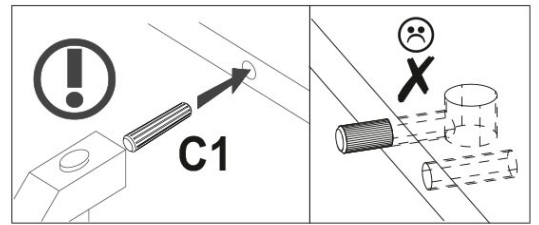
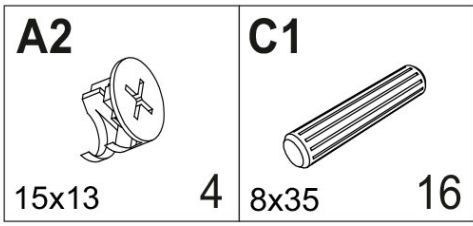

6

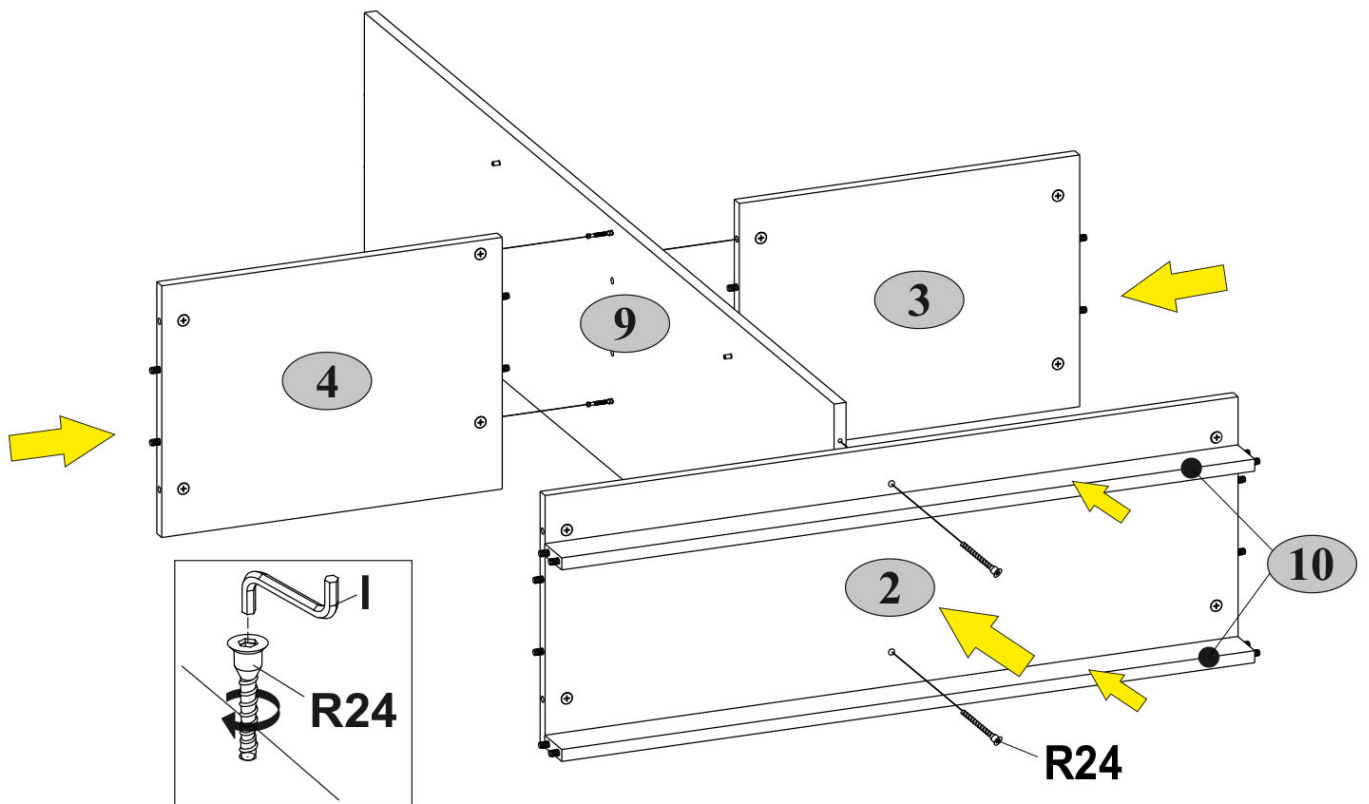
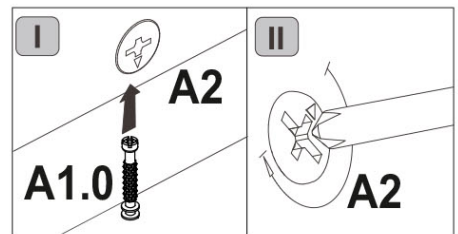
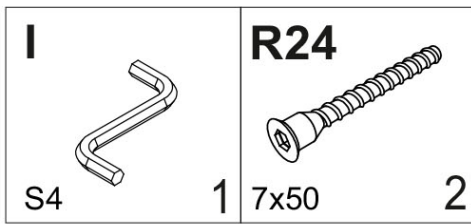

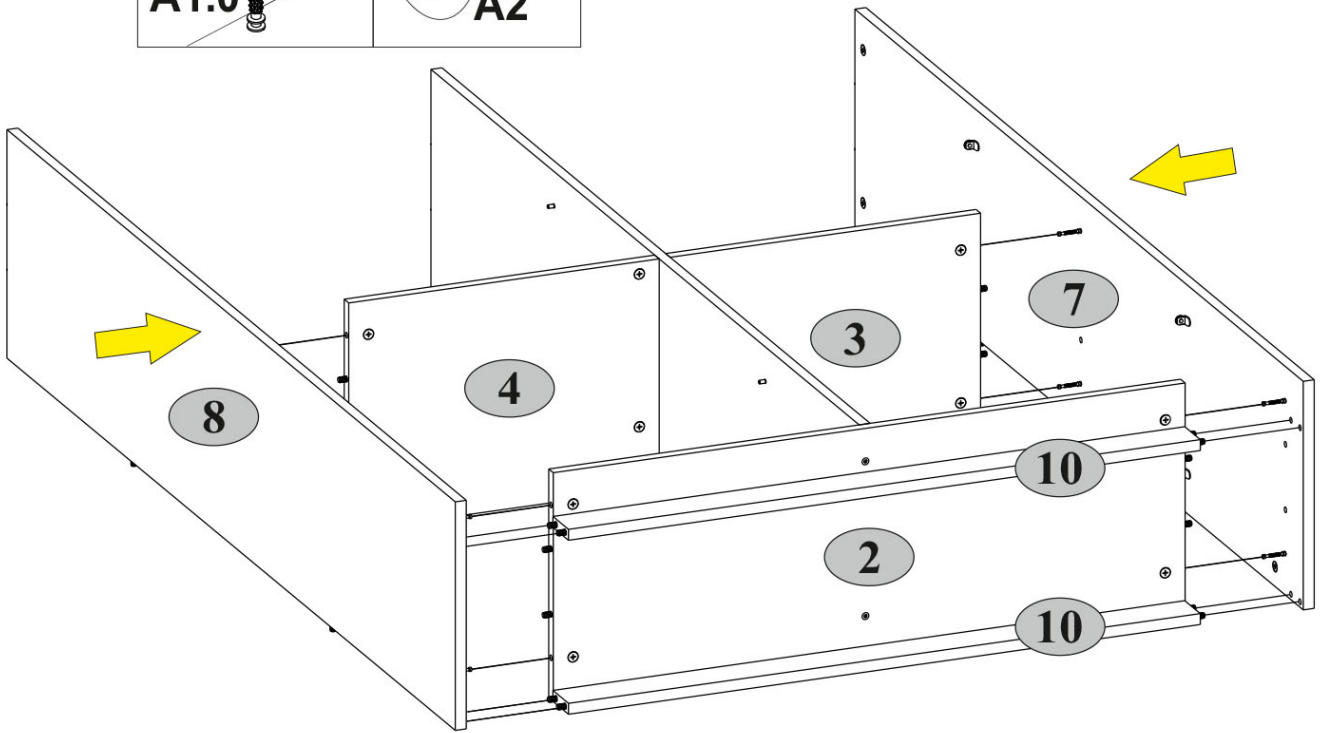
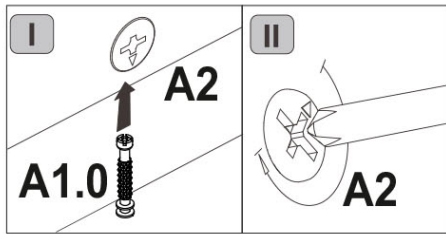

7

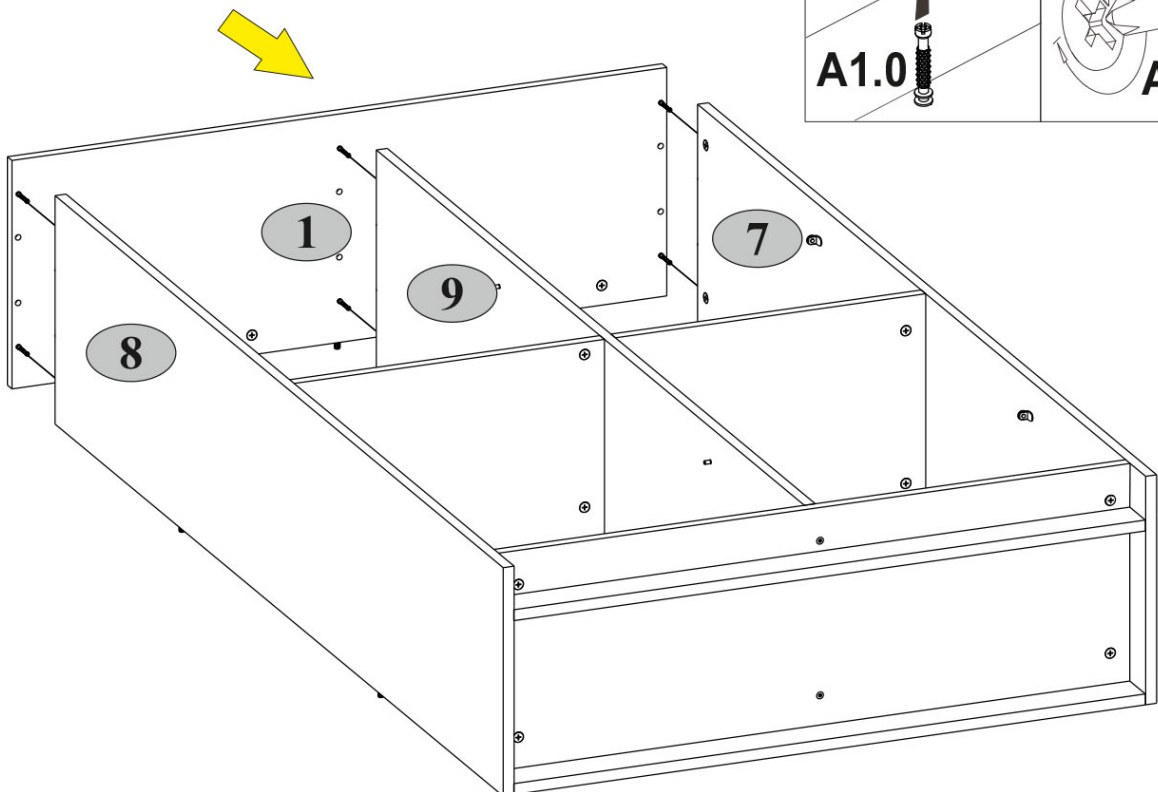
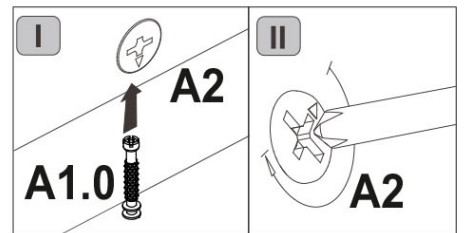

8





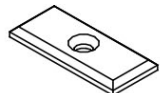

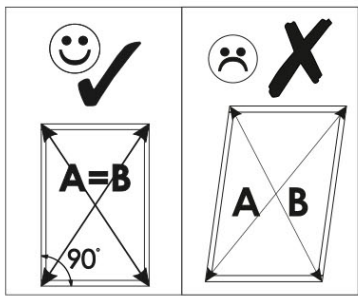
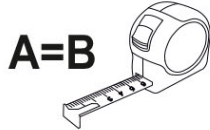
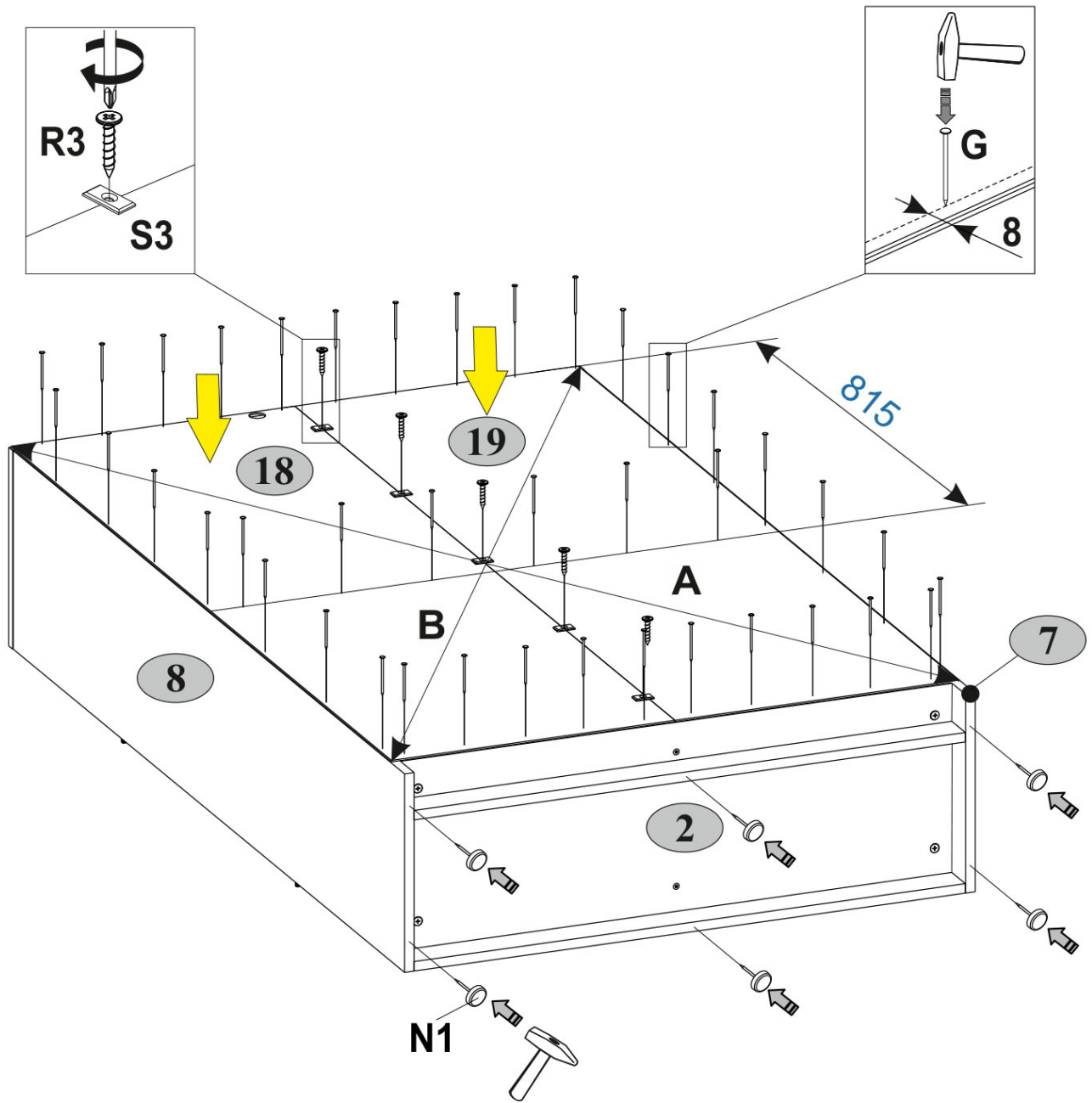
9

G  1,5x26 40	N1  6	R3  3x20 5	S3  5
---	---	---	--



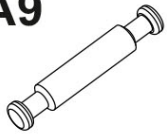
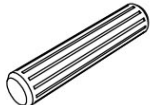
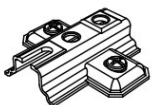

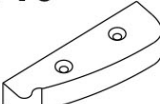

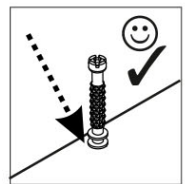
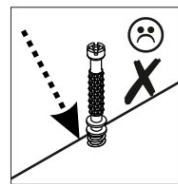
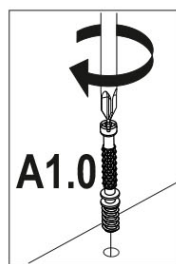
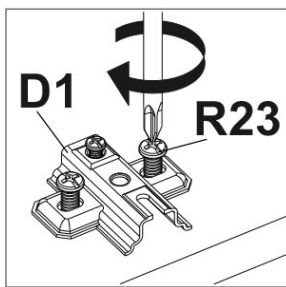
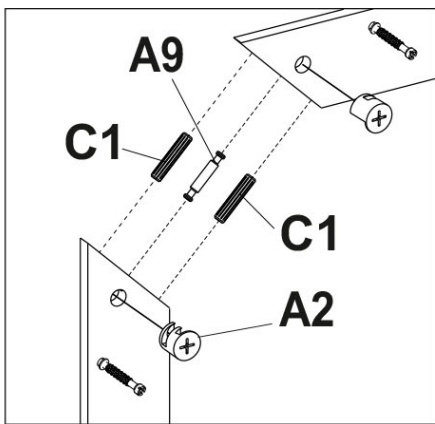
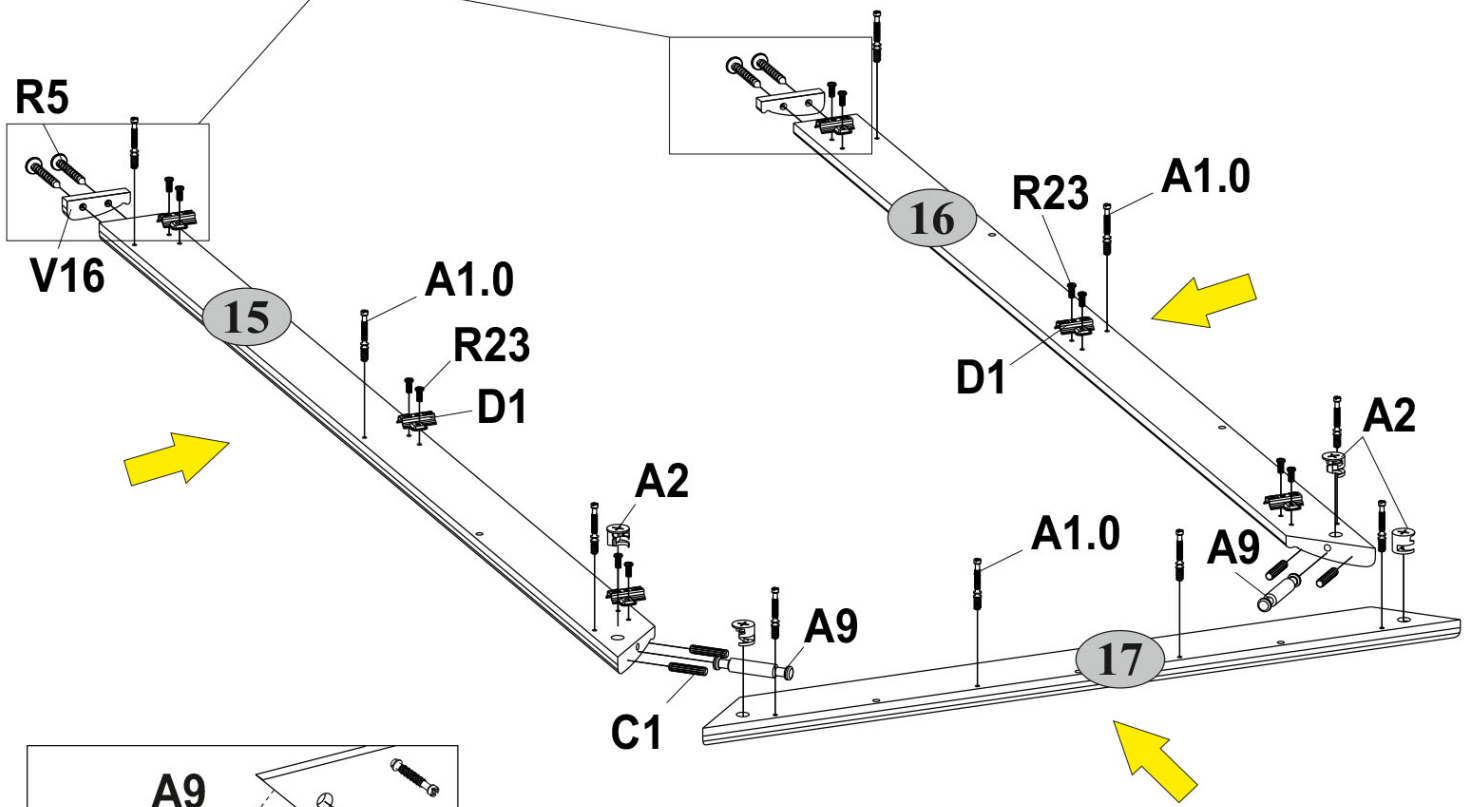
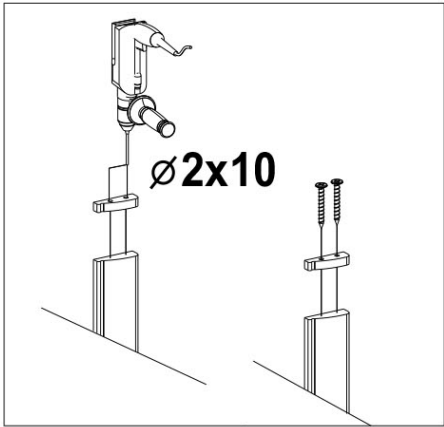
10

A1.0  5x28 10	A2  15x13 4	A9  L-47,4 2	C1  8x35 4	D1  6
R5  3x30 4	R23  6,3x13 12	V16  80x25x15 2		

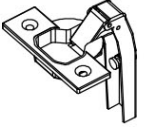

11

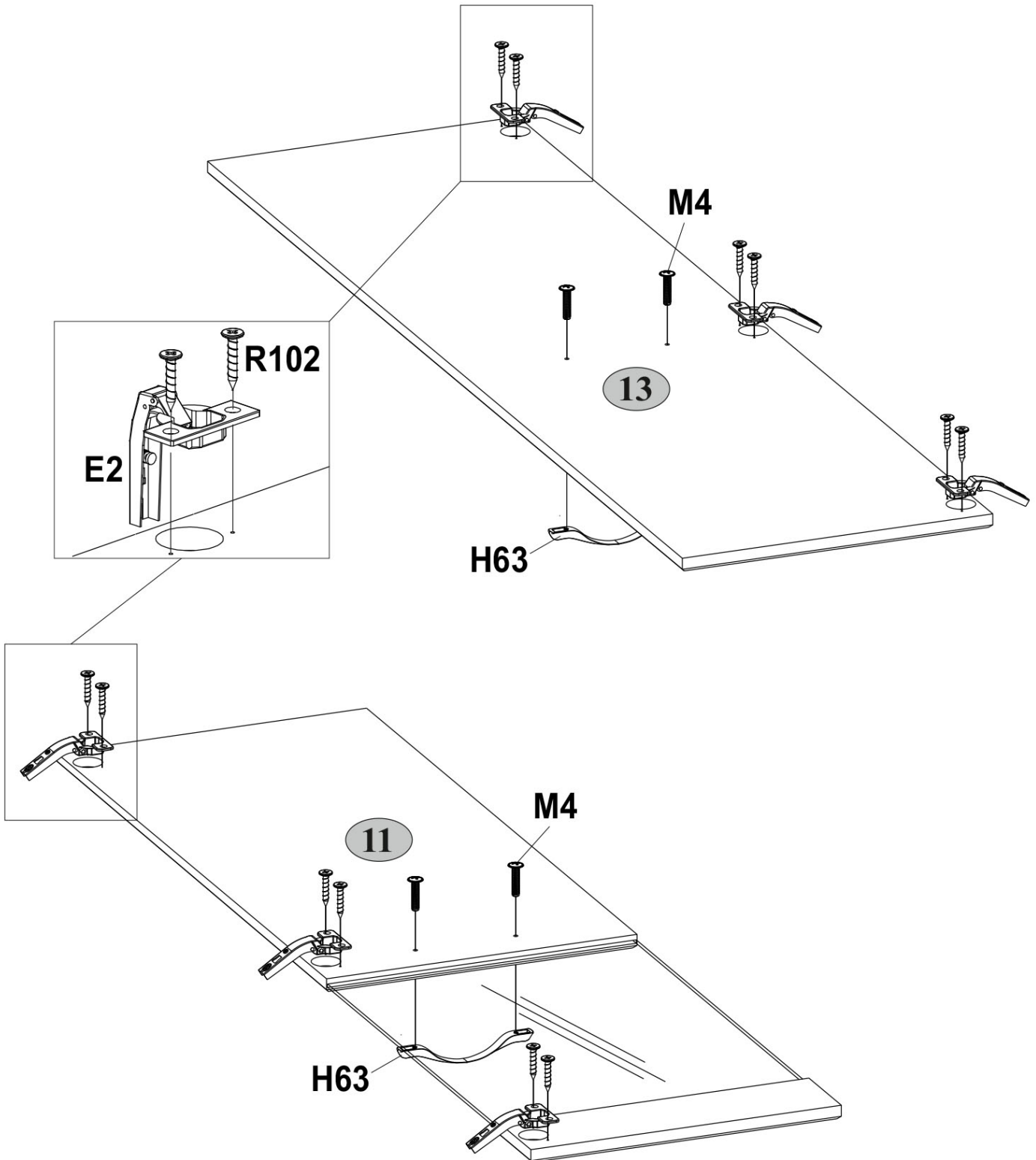

E2  6	H63  2	M4  M4x22 4	R102  3,5x16 12
---	--	---	---



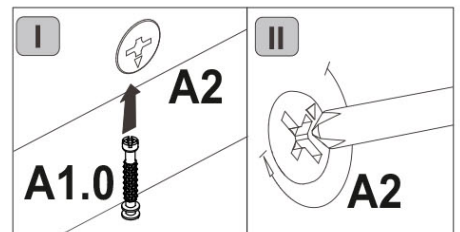
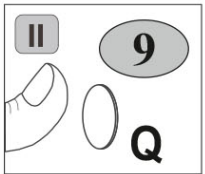
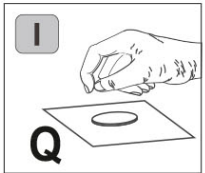
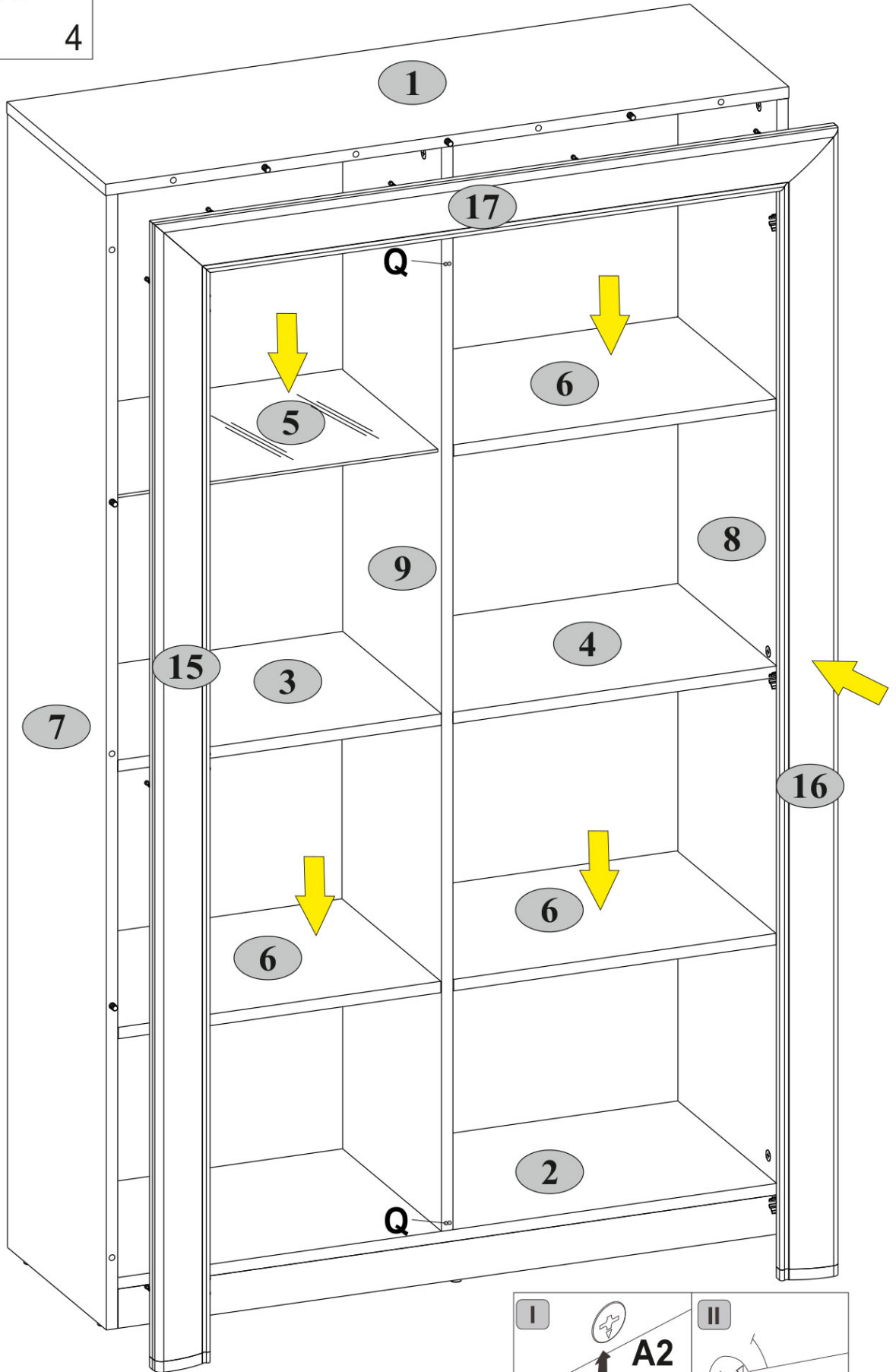
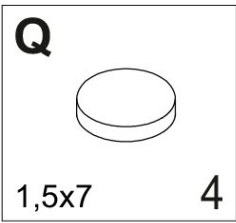



12

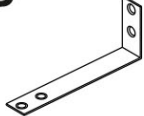

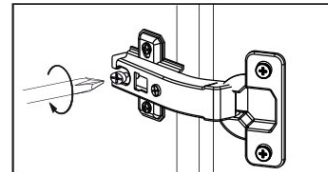
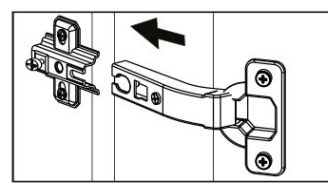
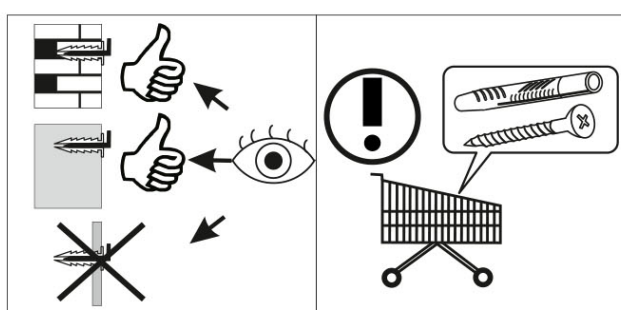
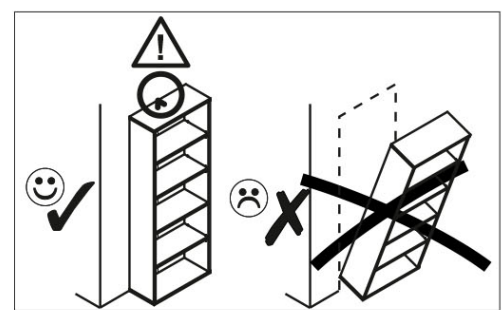
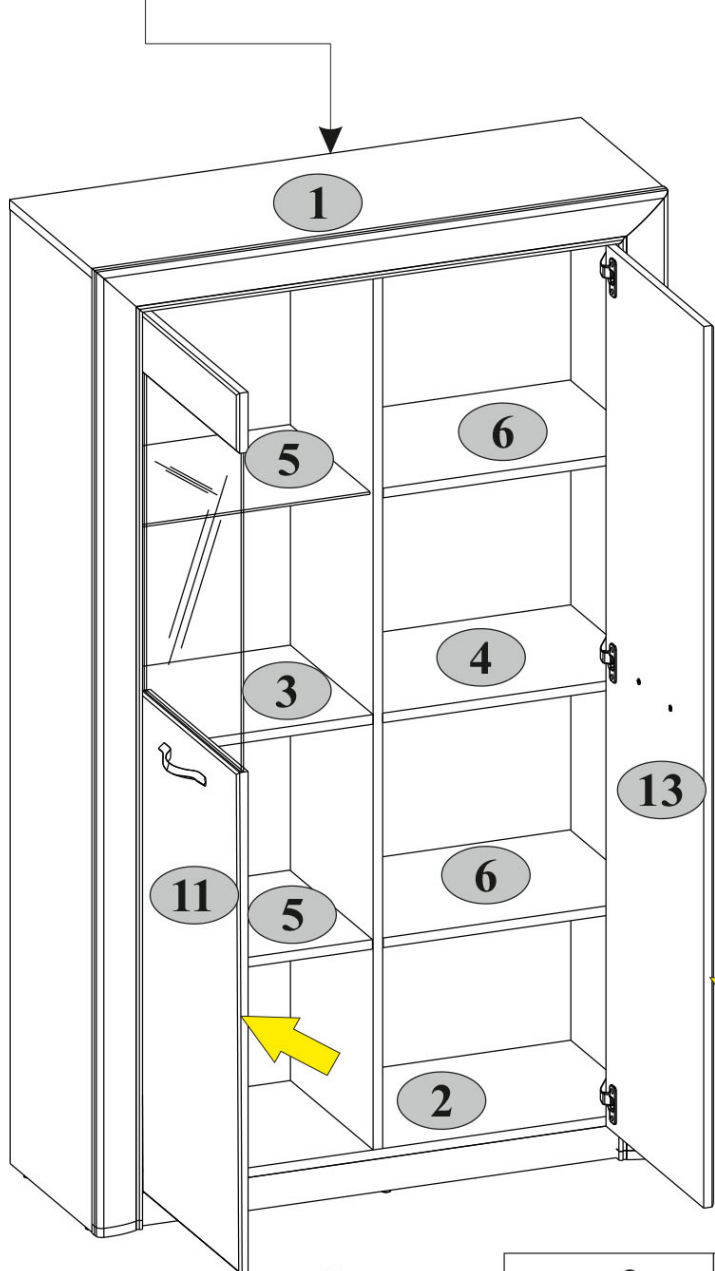
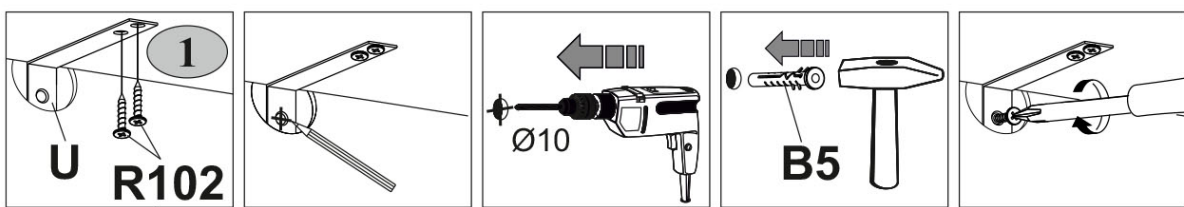
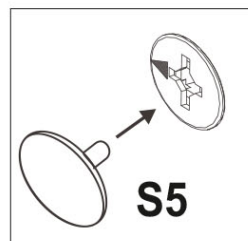
13

B5  10x50 1	R102  3,5x16 2	S5  Ø18 16	U  130x35x15 1
--	---	---	--



- 3 4 5 6**  max. 5 kg
- 1**  max. 10 kg
- 2**  max. 15 kg

